



Miniature DC Proximity Sensor Mounts in Small Spaces

- TL-Q2 and TL-Q5 models are ideal for miniature control installations
- Grooved-head TL-G3D provides high-speed pulse generation for revolution counting
- Watertight to IP67 standards
- Operation indicator on block models
- Two-wire models reduce wiring to control devices



Ordering Information

Type	Shape	Sensing distance	Output	Approval	Part Number	
Unshielded 	Rectangular	 2 mm	DC 3-wire	NO	CE	TL-Q2MC1 (See Note 1.)
			DC 2-wire	NO	CE	TL-Q5MD1 (See Note 1.)
			NC	CE	TL-Q5MD2 (See Note 1.)	
		DC 3-wire	NO	CE	TL-Q5MC1 (See Note 2.)	
		NC	CE	TL-Q5MC2 (See Note 2.)		
	Grooved	 7.5 mm		NO	---	TL-G3D-3

- Note: 1. To avoid mutual interference, this sensor can be ordered with a different oscillating frequency. Add a "5" to the end of the part number (e.g., TL-Q5MD15).
2. For applications on flexing and reciprocating equipment, this sensor can be ordered with robotic cable. Add an "R" to the end of the part number (e.g., TL-Q5MC1-R).

Specifications

■ RATINGS/CHARACTERISTICS

Part number	TL-Q2MC1	TL-Q5MD□	TL-Q5MC□	TL-G3D-3
Supply voltage (operating voltage range)	12 to 24 VDC (10 to 30 VDC), ripple (p-p): 10% max.	12 to 24 VDC (10 to 30 VDC)	12 to 24 VDC (10 to 30 VDC), ripple (p-p): 10% max.	12 to 24 VDC, ripple (p-p): 5% max.
Current consumption	15 mA max. at 24 VDC with no load	---	10 mA max. at 24 VDC	2 mA max. at 24 VDC with no load
Leakage current	---	0.8 mA max.	---	---
Detectable object type	Ferrous metal (refer to <i>Engineering Data</i> for non-ferrous metals)			Ferrous metal
Sensing distance	2 mm (0.079 in) ±15%	5 mm (0.19 in) ±10%		7.5 (0.29 in) ±0.5 mm
Sensing distance (standard object)	0 to 1.5 mm (0.059 in) (iron, 8 x 8 x 1 mm)	0 to 4 mm (0.157 in) (iron, 18 x 18 x 1 mm)	0 to 4 mm (0.157 in) (iron, 15 x 15 x 1 mm)	10 mm (0.394 in) (iron, 10 x 5 x 0.5 mm)
Differential travel	10% max. of sensing distance			
Control output (switching capacity)	NPN open collector, 100 mA max. at 30 VDC	3 to 100 mA DC	NPN open collector, 50 mA max. at 30 VDC	NPN transistor output, 20 mA max.
Operating status (with sensing object approaching)	Load ON	D1 models: Load ON D2 models: Load OFF Refer to <i>Timing Charts</i> .	C1 models: Load ON C2 models: Load OFF	Load ON
Temperature influence	±10% max. of sensing distance at 23°C (73.4°F) in the temperature range of -10°C to 60°C (14°F to 140°F)	±10% max. of sensing distance at 23°C (73.4°F) in the temperature range of -25°C to 70°C (-13°F to 158°F)	±20% max. of sensing distance at 23°C (73.4°F) in the temperature range of -25°C to 70°C (-13°F to 158°F)	±10% max. of sensing distance at 23°C (73.4°F) in the temperature range of -10°C to 55°C (14°F to 131°F)
Voltage influence	±2.5% max. of sensing distance within a range of ±10% of the rated power supply voltage	±2.5% max. of sensing distance within a range of ±15% of the rated power supply voltage	±2.5% max. of sensing distance within a range of ±10% of the rated power supply voltage	
Response time	---		2.0 ms max.	1 ms max.
Response frequency (See Note.)	0.5 kHz			
Circuit protection	Reverse connection protection and surge absorber	Load short-circuiting protection and surge absorber	Reverse connection protection and surge absorber	Surge absorber
Residual voltage	1.0 V max. with a load current of 100 mA and a cord length of 2 m (78.74 in)	3.3 V max. with a load current of 100 mA and a cord length of 2 m (78.74 in)	1.0 V max. with a load current of 50 mA and a cord length of 2 m (78.74 in)	---
Indicator	Detection indicator	D1 models: Output indicator (red) and setting indicator (green) D2 models: Output indicator (red)	Detection indicator	---
Material	Case	Heat-resistant ABS resin		
	Sensing surface	Heat-resistant ABS resin		
Weight	Approx. 30 g (1.06 oz) (with 2-m cable)	Approx. 45 g (1.59 oz) (with 2-m cable)	Approx. 60 g (2.12 oz) (with 2-m cable)	Approx. 30 g (1.06 oz) (with 1-m cable)
Enclosure rating	IEC60529 IP67			IEC IP66
Ambient temperature	Operating	-10°C to 60°C (14°F to 140°F) with no icing		
Ambient humidity	Operating	35% to 95%		
Vibration resistance	10 to 55 Hz, 1.5-mm double amplitude for 2 hours each in X, Y, and Z directions			

(This table continues on the next page.)

Specifications Table – continued from previous page

Part number	TL-Q2MC1	TL-Q5MD□	TL-Q5MC□	TL-G3D-3
Shock resistance	1,000 m/s ² (3,280.8 ft/s ²) approx. 100G for 10 times each in X, Y, and Z directions	500 m/s ² (1,640 ft/s ²) approx. 50G for 3 times each in X, Y, and Z directions	200 m/s ² (656 ft/s ²) approx. 20G for 10 times each in X, Y, and Z directions	
Insulation resistance	50 MΩ min. (at 500 VDC) between current carry parts and case		5 MΩ min. (at 500 VDC) between current carry parts and case	
Dielectric strength	1,000 VAC, 50/60 Hz for 1 min between current carry parts and case		500 VAC, 50/60 Hz for 1 min between current carry parts and case	

Note: The response frequencies of the DC switching components are average values obtained by measuring in sequence a line-up of standard sensing objects. The space between any adjacent sensing objects was twice the width of a single sensing object and the setting distance was half the maximum sensing distance.

Operation

■ OUTPUT CIRCUITS AND TIMING CHARTS

DC 2-wire Model

TL-Q5MD

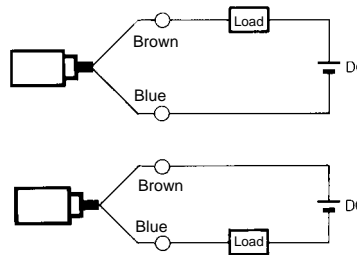
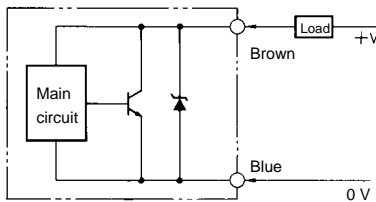

Note: The load can be connected in two ways as shown in the above diagrams.

Timing Charts

Normally Open

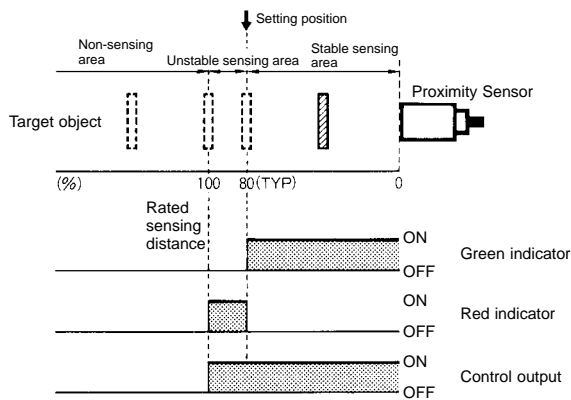

Normally Closed

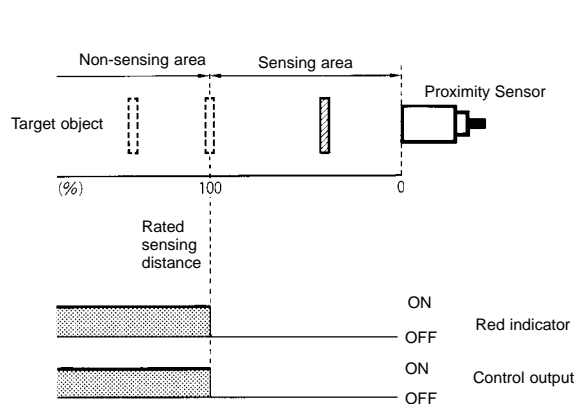

DC 3-wire Models

TL-Q2

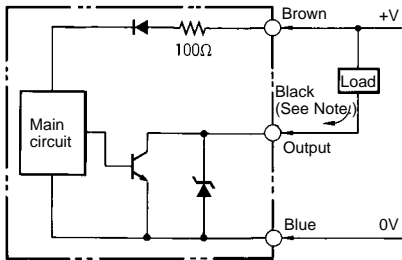

Note: Max. load current: 100 mA

TL-G3D-3

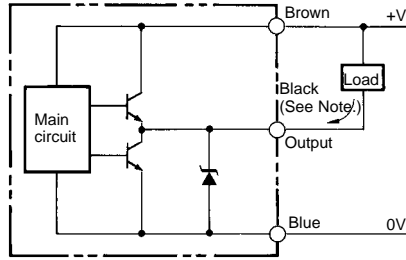

Note: Max. load current: 20 mA

TL-Q5MC

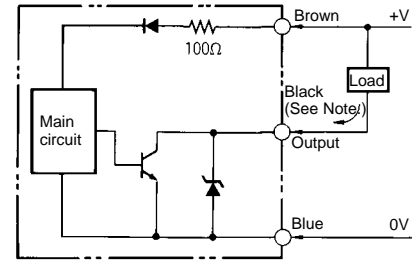

Note: Max. load current: 50 mA

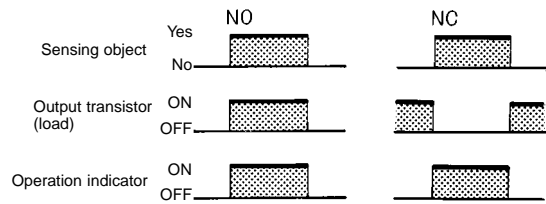
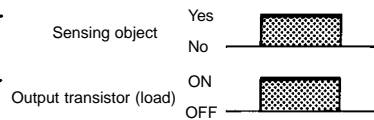
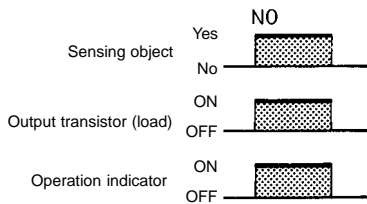

Engineering Data

OPERATING RANGE (TYPICAL)

TL-Q2 (Rectangular Model)

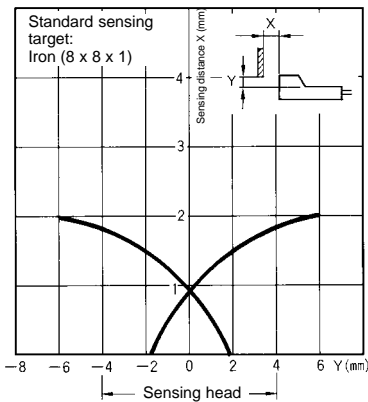

TL-Q5M (Rectangular Model)

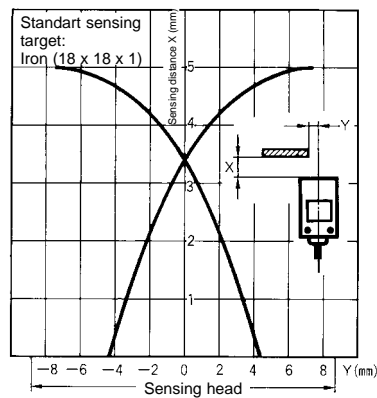

■ TARGET OBJECT THICKNESS AND MATERIAL VS. SENSING DISTANCE (TYPICAL)

TL-G3D-3 (Grooved)

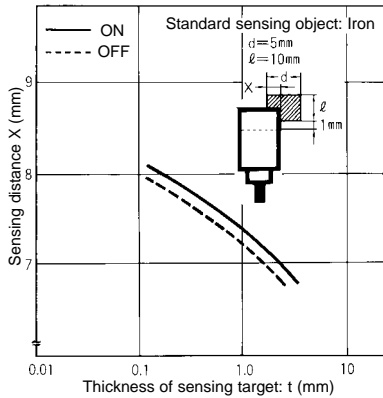

TL-G3D-3 (Grooved)

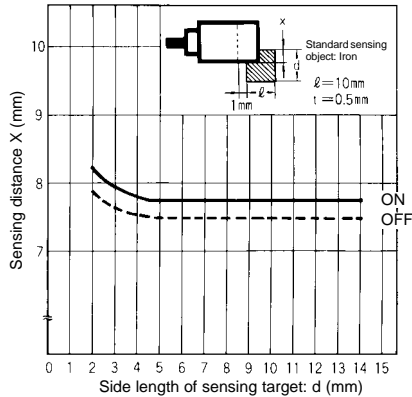

TL-Q5MC□ (Rectangular Model)

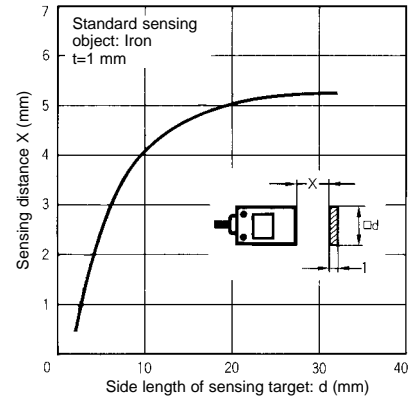

■ TARGET OBJECT SIZE AND MATERIAL VS. SENSING DISTANCE (TYPICAL)

TL-Q2

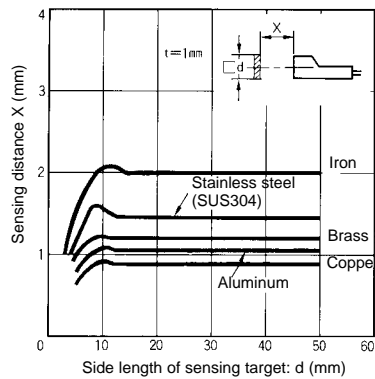

TL-Q5

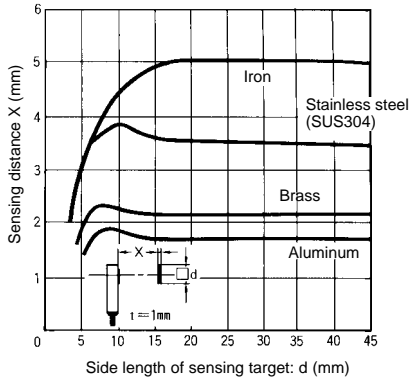

Dimensions

Unit: mm (inch)

■ TL-Q2

Thin Model

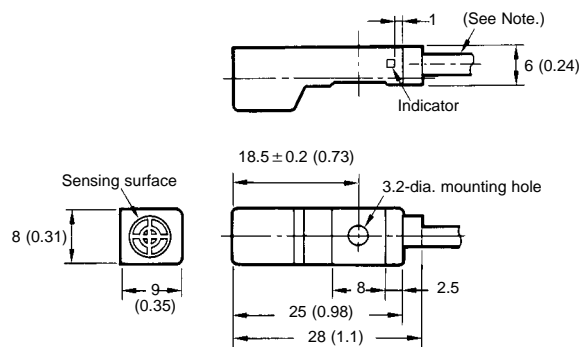
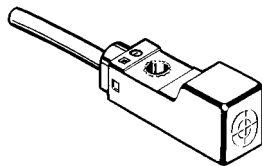

Note: 2.9-dia. vinyl-insulated round cable with 3 cores (0.12 dia. x 13); standard length: 2 m

■ TL-G3D-3

Grooved Model

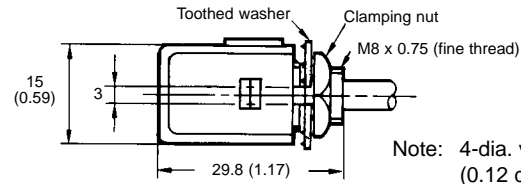
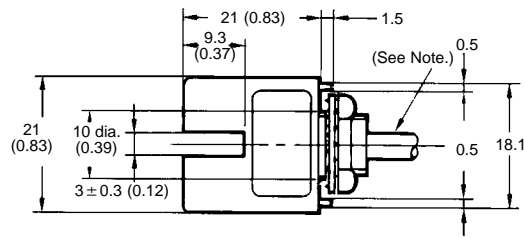
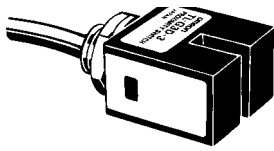

Note: 4-dia. vinyl-insulated round cable, 3 cores (0.12 dia. x 18); standard length: 1 m

Mounting Dimensions

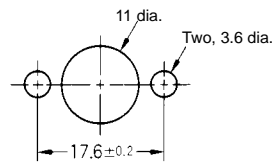

■ TL-Q5M

Block Model

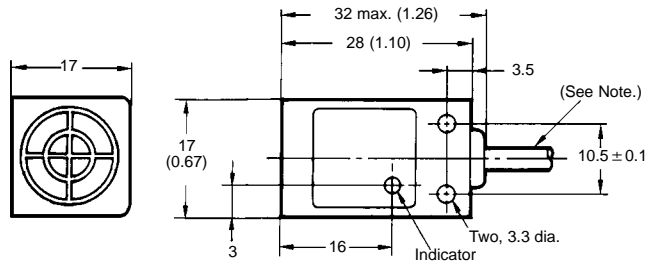
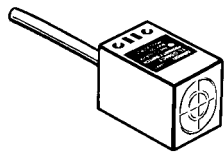

Note: 4-dia. vinyl-insulated round cable, 0.2 dia. x 3 cores, 0.3 dia. x 2 cores; standard length: 2 m

Mounting Dimensions

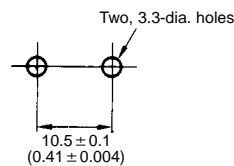

Precautions

■ TIGHTENING FORCE

Do not tighten any mounting screw with a torque exceeding the maximum tightening torque described in the table to the right.

Model	Tightening torque
TL-Q2M□□	6 kgf • cm (0.59 N • m) 0.43 ft • lbf
TL-Q5M□□	6 kgf • cm (0.59 N • m) 0.43 ft • lbf
TL-G3D-3	20 kgf • cm (2 N • m) 1.47 ft • lbf

■ EFFECTS OF SURROUNDING METALS AND MUTUAL INTERFERENCE

Be sure to keep at least the following distances between the Sensor and the surrounding metal objects.

Effects of Surrounding Metals

Rectangular Models

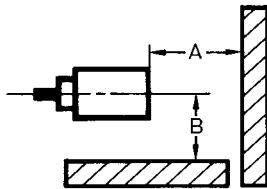

Model	A	B
TL-Q5M	20 mm (0.787 in)	20 mm (0.787 in)

Thin Models

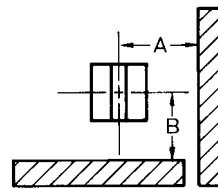

Model	A	B
TL-G3D-3	11 mm (0.433 in)	17 mm (0.669 in)

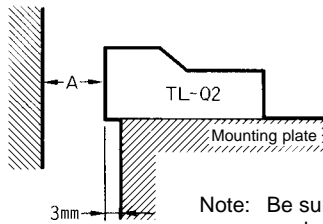

Note: Be sure that the mounting plate is made of non-ferrous metal.

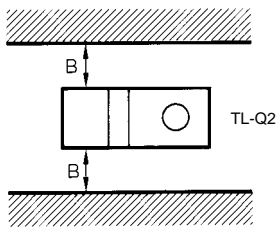

Model	A	B
TL-Q2	12 mm (0.47 in)	3 mm (0.118 in)

Parallel or Face-to-face Mounting

Rectangular Models

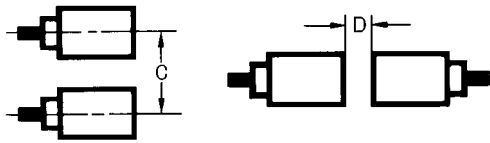

Model	C	D
TL-Q5MC	60 mm (2.36 in)	120 mm (4.7 in)
TL-Q5MC□5	17 mm (0.67 in)	60 mm (2.36 in)
TL-Q5MD	60 mm (2.36 in)	120 mm (4.7 in)
TL-Q5MD□5	30 mm (1.18 in)	80 mm (3.15 in)

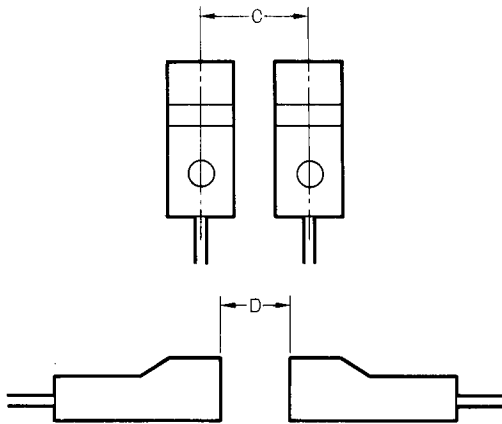

Model	C	D
TL-Q2	30 mm (1.18 in)	90 mm (3.54 in)
TL-Q2□5	8 mm (0.32 in)	45 mm (1.77 in)

Thin Models

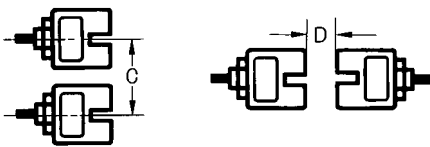

Model	C	D
TL-G3D-3	31 mm (1.22 in)	25 mm (0.98 in)

SENSING TARGETS AND POSITION CONTROL

TL-G3D-3 Grooved Model

If the TL-G3D-3 is in high-speed response operation with a toothed metal plate, be sure that the target object size is as large as or larger than the standard object size and that the target objects are separated enough from one another.

The response frequency obtainable when the following toothed metal plate is used will be 1 kHz or higher. If the metal plate is smaller with shorter teeth and narrow adjacent space, the response frequency will decrease.

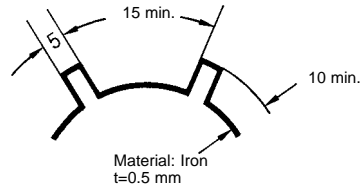

Be sure that the distance between the bottom of the groove and the sensing object is 1 mm or less.

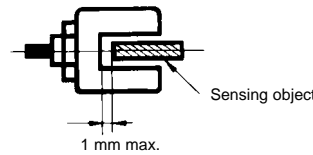

TL-Q Rectangular Model

The sensing distance decreases with non-ferrous metal. Refer to *Target Object Size and Material vs. Sensing Distance (Typical)* in *Engineering Data*. If the target is a metal foil that is as thin or thinner than 0.01 mm, there will be little difference in sensing distance between the metal foil and ferrous metal. If the target is, however, extremely thin (e.g., metal-coating film) or not conductive, the object will not be detected.

INFLUENCE OF PLATING

The following percentage values indicate decreases or increases in sensing distance on the basis of the sensing target with no metal plating as 100%.

Metal plating type and thickness	Material
	Iron
No metal plating	100
Zn5 to 15 μm	90 to 120
Cd5 to 15 μm	100 to 110
Ag5 to 15 μm	60 to 90
Cu10 to 20 μm	70 to 95
Cu5 to 15 μm	---
Cu (5 to 10 μm) + Ni (10 to 20 μm)	75 to 95
Cu (5 to 10 μm) + Ni (10 μm) + Cr (0.3 μm)	75 to 95

NOTE: DIMENSIONS SHOWN ARE IN MILLIMETERS. To convert millimeters to inches divide by 25.4.

OMRON[®]
OMRON ELECTRONICS, INC.
One East Commerce Drive
Schaumburg, IL 60173
1-800-55-OMRON

OMRON CANADA, INC.
885 Milner Avenue
Scarborough, Ontario M1B 5V8
416-286-6465

Mouser Electronics

Authorized Distributor

Click to View Pricing, Inventory, Delivery & Lifecycle Information:

Omron:

[TL-Q5MC1](#) [TL-Q5MC1-R](#) [TL-Q5MD15](#) [TL-Q5MC2](#) [TL-Q5MD1](#)